

BALTON®

B III



161110

161118

161114

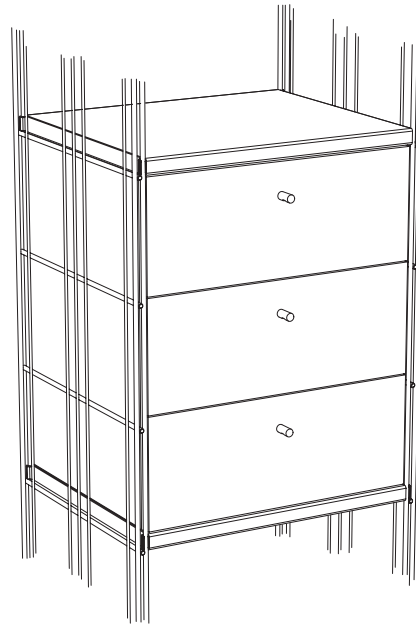
161112



| | | | |
|----------|---|---|---|
| |  |  |  |
| 1 | X6 | | |
| 2 | | X6 | |
| 3 | | | X3 |

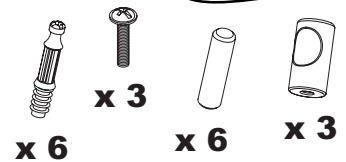
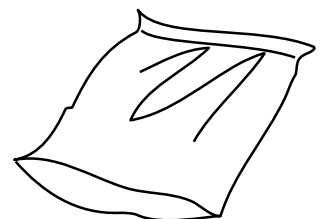
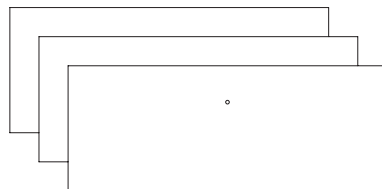
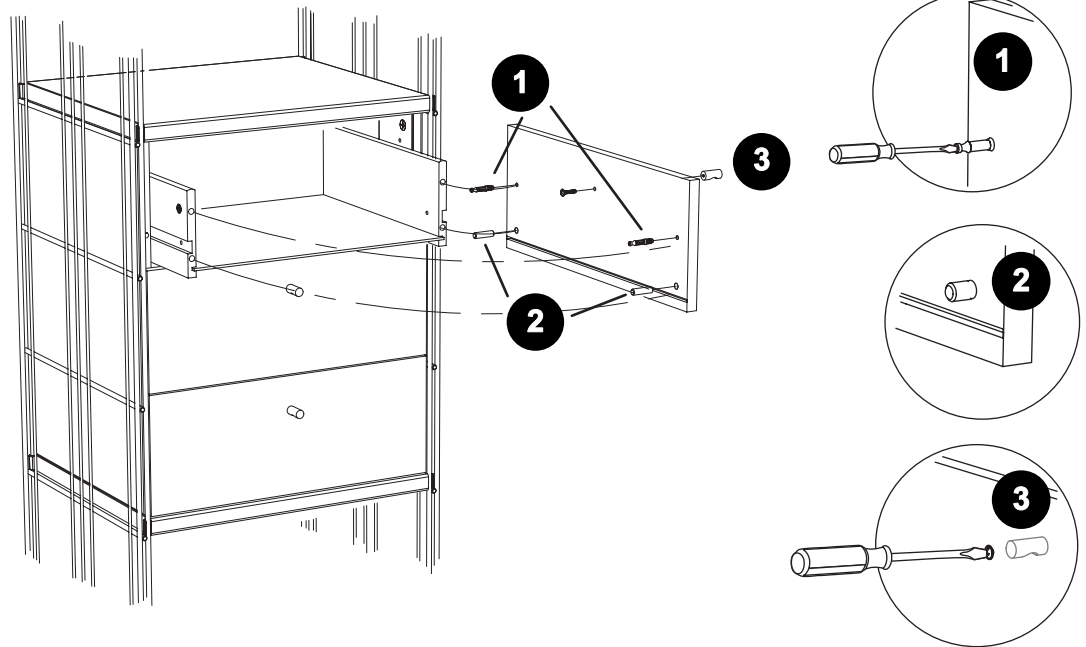

info@balton.se