

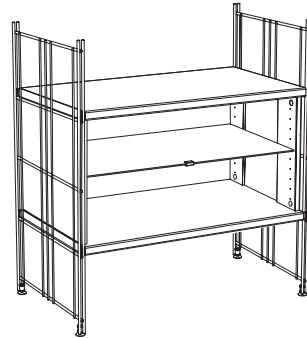

BALTON®

B III  
151 370

B III 151 370 02/2008 - X-10

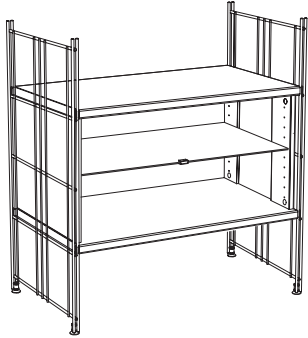
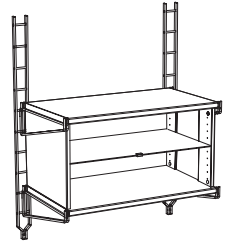
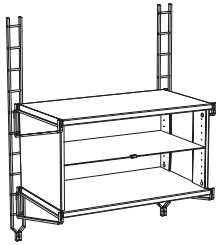

 **Unos consejos**

Después de unas semanas se debe de controlar y asegurar de nuevo los tornillos y bolones. Para la limpieza se recomienda utilizar solamente agua y un detergente de jabón suave. Seque con un trapo seco suave. Otros métodos de limpieza pueden causar daños que la garantía no cubre.

 **Noch einige gute Tips**

Nach ungefähr einer Woche sollten die Schrauben und Bolzen überprüft und nachgezogen werden. Die Reinigung des Schranks erfolgt nur mit Wasser und milder Seifenlauge, anschließend mit einem weichem Lappen trockenreiben. Andere Reinigungsmethoden bzw. -mittel können Schäden verursachen, für die der Hersteller nicht haftet.

 **Some useful advice**

You should check and re-tighten the screws and bolts a few weeks after assembly. For cleaning, use mild soapy water only and dry with a soft cloth. Other cleaning agents may cause damage not covered by the warranty.

 **Quelques bons conseils**

Après quelques semaines, il convient de contrôler et de resserrer les vis et les boulons. Pour le nettoyage, utilisez de l'eau savonneuse douce. Essuyez avec un chiffon doux. D'autres méthodes de nettoyage peuvent causer des dommages non-couverts par la garantie.

BALTON®  
info@balton.se

 **Instrucciones de montaje**

Fabricado en Suecia.

 **Montageanleitung**

Hergestellt in Schweden.





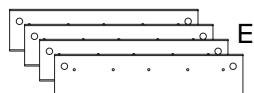
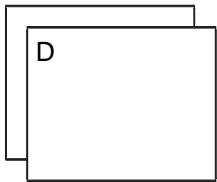
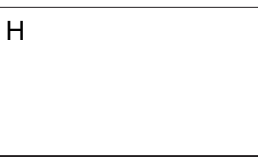
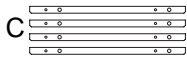
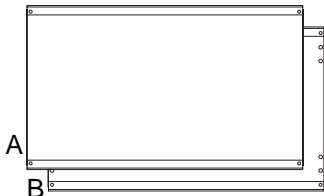

 **Assembly Instructions**

Made in Sweden.

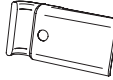
 **Instructions de montage**

Fabriqué en Suède.



8 	8 	8 	8 	4 
1 	8 			

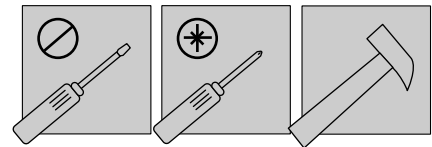

 **Antes del montaje**

Lea cuidadosamente las instrucciones antes de empezar el montaje. Controle el contenido del embalaje. Póngase en contacto con su distribuidor si encuentra algo deficiente o que falta. Asegúrese de que las herramientas marcadas están disponibles. Efectue el montaje paso a paso según el manual.

 **Vor der Montage**

Lesen Sie bitte als erstes die Montageanleitung sorgfältig durch. Überprüfen Sie den Verpackungsinhalt. Falls Teile fehlen oder defekt sind, setzen Sie sich bitte mit Ihrem Fachhändler in Verbindung. Achten Sie darauf, daß die schraffiert dargestellten Werkzeuge bereitliegen. Die Montage erfolgt schrittweise gemäß Anleitung.

 **Before assembly**

Read through the instructions carefully before starting assembly. Check the contents of the package. Contact the point of sale if you find anything defective or missing. Make sure that the shaded tools are available. Assemble step by step as shown in the instructions.

 **Avant le montage**

Lisez attentivement les instructions avant de commencer les travaux de montage. Contrôlez le contenu de l'emballage. En cas de pièces endommagées ou manquantes, contactez le distributeur. Assurez-vous que les outils nécessaires sont disponibles. Effectuez le montage étape par étape en suivant les instructions.

